

# 地下基础施工 整体解决方案专家

EXPERTISE IN DELIVERING TURNKEY SOLUTIONS  
TO DEEP FOUNDATION ISSUES



# D系列 筒式柴油打桩锤

D Series Diesel Pile Hammer

# D系列筒式柴油打桩锤

## D Series Diesel Pile Hammer

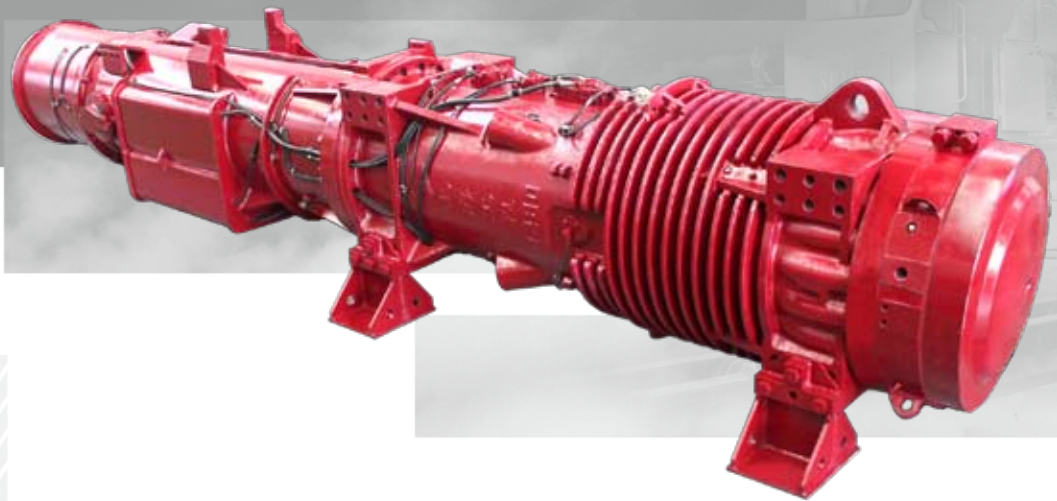

### 公司简介 COMPANY OVERVIEW

上海工程机械厂有限公司成立于1921年。公司主要从事TRD工法机、静钻根植工法钻机、全回转套管钻机、多轴式连续墙钻机、全液压履带式、步履式打桩架、筒式柴油锤、电动振动锤、液压打桩锤等地下基础施工机械产品的设计、制造和销售。主要为高速公路、高层建筑、桥梁、地铁、机场、码头、电站等大型、特大型工程施工提供机械和服务。

近年来，公司先后获得了上海市高新技术企业、上海市科技小巨人（培育）企业、上海市专利试点企业、上海市著名商标、上海名牌上海市名牌产品等荣誉称号，公司技术中心被认定为闸北区区级企业技术中心。

**世界上最大打击能量的柴油锤、最大打击能量的电驱振动锤、最大钻孔深度的钻孔机、最大立柱高度的打桩架等都曾诞生在本公司。**

Shanghai Engineering Machinery Co., Ltd. (SEMW)—founded in 1921. SEMW is specialized in design, manufacturing and distribution of pile driving and deep foundation equipment. SEMW currently produces Trench Cutting & Re-mixing Deep Wall Equipments, SDP110 Pre-bored Pre-cast Piling Equipment, CRD-200H full casing rotary drilling rig, Multi-shaft Agitating Augers, Hydraulically driven Pile Driving Rigs, Hydraulic Walking Piling Rigs, D series Diesel Pile Hammers, Vibratory Hammers, Hydraulic Hammers. Our products are widely used on high profile and long term engineering projects, such as, expressways, skyscrapers, bridges, subways, airports, deep-water docks, power stations, and more.

With years of independent research and development, SEMW products have recently been awarded "Shanghai New Hi-tech Achievement Transformation Project", "Shanghai Science and Technology Progress Award" and "Shanghai Famous Industrial Product".

**SEMW currently produces the Diesel Hammers with the highest obtainable energy, Vibratory Hammers with the highest drive forces, Agitating Augers that can drill the deepest holes and Piling Rigs with the highest leader in the world.**

# D8~D100筒式柴油打桩锤——百年积淀 “撼动” 全球

## D8~D100 DIESEL PILE HAMMERS: DRIVE THE WORLD

- 强劲有力，打击能量大——更高效
- 油耗低，故障率低——更经济
- 维修及时，快捷——更方便
- More efficient –More power & Higher obtainable energy
- More economical –Higher fuel efficient & Less maintenance requirements
- More convenient – Easy maintenance

### 案例展示——国内 CASE: JOBSITES IN CHINA



上海东方明珠项目  
The Oriental Pearl Tower, Shanghai



上海延安路高架项目  
Yan'an Elevated Expressway, Shanghai



上海磁悬浮项目  
Shanghai Maglev Train



上海金茂大厦项目  
JinMao Tower, Shanghai

### 案例展示——国际 CASE: JOBSITES OVERSEAS



印度尼西亚 Indonesia



土耳其 Turkey



俄罗斯 Russia



泰国 Thailand



越南广南 Vietnam





## 产品技术参数 SPECIFICATIONS

型号		D8-22 斜桩最大 倾斜度 (1:2)	D12-42 斜桩最大 倾斜度 (1:2)	D16-32 斜桩最大 倾斜度 (1:2 1:1)	D19-42 斜桩最大 倾斜度 (1:2 1:1)	D25-32 斜桩最大 倾斜度 (1:3 1:1)	D30-32 斜桩最大 倾斜度 (1:3 1:1)	D36-32 斜桩最大 倾斜度 (1:3 1:1)	D46-32 斜桩最大 倾斜度 (1:3 1:1)	D62-22 斜桩最大 倾斜度 (1:2 1:1)	D80-23 斜桩最大 倾斜度 (1:2 1:1)	D100-13 斜桩最大 倾斜度 (1:5 1:2)	
上活塞重量 Impact weight(piston)	kg	800	1280	1600	1820	2500	3000	3600	4600	6200	8000	10000	
每次打击能量 Energy per blow	j	≤23940	≤42460	≤53460	≤57585	≤78970	≤94765	≤113720	≤145305	≤218960	≤266830	≤333540	
打击次数 Number of blows	1/min	≥38	≥36	≥36	≥37	≥37	≥37	≥37	≥37	≥36	≥36	≥36	
作用于桩上的最大爆炸力 Force of explosion pressure on pile max	kn	505	606	686	686	1304	1304	1695	1695	1800	2600	2600	
适宜打桩规格最大为 Suitable for driving piles upto (上述参数主要依据于混凝土桩的平均值, 根据土壤条件可能存在误差) (The datas mentioned refers to average values mainly valid concrete piles. Depending on the soil conditions deviations are possible.)	kg	2500	4500	5000	6000	7000	8000	10000	15000	25000	30000	40000	
起落架导向滑轮钢丝绳直径最大为 Permissible rope diameter for deflector sheave of tripping device max.	mm	Ø20	Ø20	Ø20	Ø20	Ø22	Ø22	Ø38	Ø38	Ø38	Ø30	Ø30	
油耗 Consumption	柴油 Diesel oil l/h	4	4.5	5.5	6.6	8	10	11.5	16	20	25	30	
	润滑油 Lubricant l/h	1	1	1	1	1	1	2	2	2.30	2.90	2.90	
容量 Capacity	打直桩时柴油箱容积 Capacity for vertical pilig Diesel oil tank	20	27	32	32	67	67	89	89	98	155	155	
	润滑油箱容积 Capacity of lubricant oil tank	6	7	9	9	19	19	17	17	31.5	32	32	
	乙醚箱容积 Ether tank	1	/	1.20	1.20	1.70	1.70	1.50	1.50	1.50	1.0	1.0	
重量 Weights	柴油锤重约 Diesel pile hammer approx	kg	1950	3000	3250	3550/3695	5330/5610	5830/6110	7800/8190	8800/9190	11870/12280	16365/16905	19820/20360
	起落架重约 Tripping device approx	kg	100	100	100	100	180	180	400	400	400	750	750
	搬运托架/支架 Transpor bracket/crddle approx	kg	11	11	11	11	20	20	31.5	31.5	72	135	135
	运输时保护装置 Transpor guard approx	kg	15	15	15	15	23	23	25	25	34	220	220
	工具箱 Tool box approx	kg	75	75	75	75	100	100	100	100	125	125	125
尺寸 Dimensions	柴油锤高 (a/a1) Length of Desel pile hammer	mm	4954	5070	4984/5570	4984/5570	5514/5570	5514/6260	5539/6285	5539/6285	6164/6910	6454/7200	6612/7358
	下活塞外径 (b) Outer diametr of impact block	mm	350	430	440	440	560	560	660	660	710	820	820
	导向板螺钉外侧间距 (c) Over all dimensions measured over fastening screws of the guide jaws	mm	560	560	560	560	780	780	880	880	828	1110	1110
	柴油锤宽 (d) Width of Diesel pile hammer	mm	410	440	485	485	640	640	785	785	800	890	890
	连接导向板宽 (e) Width for connection of guide jaws	mm	320	320	320	320	540	540	640	640	560	800	800
	柴油锤中心到燃油泵保护装置的距离 (f) Centre of Diesel pile hammer up to pump guard	mm	315	335	345	345	405	405	445	445	490	550	550
	柴油锤中心到导向板螺钉中心的距离 (g) Centre of Diesel pile hammer up to centre of threaded hole for fastening screws of the guide jaws	mm	245	245	280	280	235	235	275	275	380	350	350
	柴油锤纵向深 (h) Depth of Diesel pile hammer	mm	590	610	665	665	715	715	848	848	970	1110	1110
	柴油锤中心到导向中心的距离 (H) Minmum(standard)distance from centre of Diesel pile hammer up to the centre lead	mm		405	440	440	500	500	530	530	560	720	720
	导向中心间距 (I) Guiding center spacing	mm					330(×Ø70)					600(×Ø102)	

技术参数的更改恕不另行通知。 Specifications are subjected to change without prior notice.

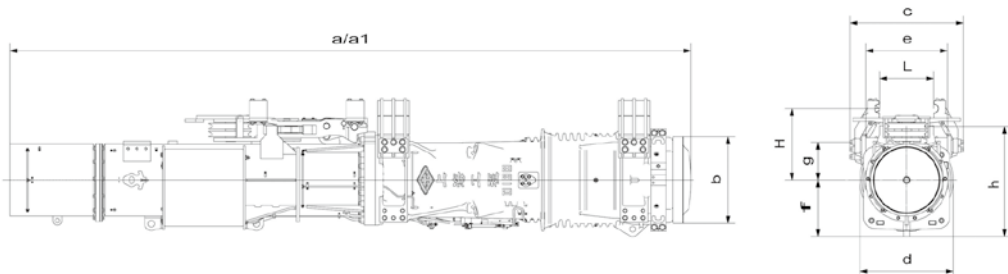

## 八边形柴油打桩锤——专业设计“特色定制”

### OCTAGON DIESEL PILE HAMMERS—CUSTOMIZED & PROFESSIONAL DESIGN



上海工程机械厂有限公司独立开发的八边形柴油打桩锤，专为美国市场量身定制。产品按照美国施工方法设计制作，满足客户的高标准要求。产品一经推出，反响强烈，获得北美市场的一致好评。展示出上海工程机械厂有限公司产品设计理念的兼容性和在国外的影响力。

SEMW independently developed custom made Octagon shaped Diesel Hammers, specialized for the American market. The hammers are designed according to our customer's requirement; and designed for the construction process used in the United States. Octagon Diesel Hammers are well received in North America, which demonstrates our ability to influence and expands the ever-growing SEMW product line around the world.

#### 美国APE案例 CASE: APE, USA

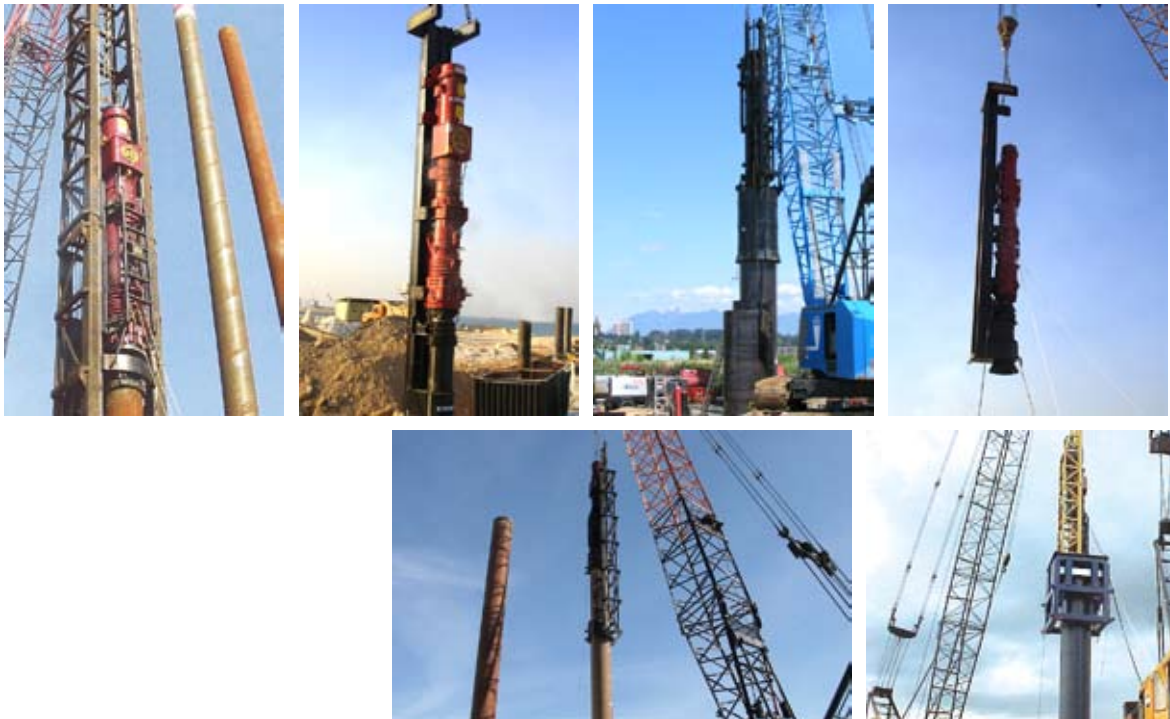

## D128~D300筒式柴油打桩锤——海洋工程 装备专家

### D128~D300 DIESEL PILE HAMMERS: SPECIALIZED IN OFFSHORE CONSTRUCTION

- 大吨位、大能量—— 桩定乾坤 稳如泰山
- 自主研发、独有技术—— 因为专业 所以领先
- 海上风电、跨海大桥、海上石油平台—— 开拓海洋 装备先行
- Heavy duty & High energy hammers provide solutions for today's offshore market
- Intellectual property & Advanced technology provides Professional solutions
- Offshore wind powers, Cross-sea bridges and Oil platforms better explores the ocean



### 案例展示——国内 CASE: JOBSITES IN CHINA



浙江杭州湾跨海大桥D180柴油锤  
Hangzhou Bay Bridge, Zhe jiang, With D180



东海风电一期二期D220柴油锤  
Donghai Bridge Wind farm, Shanghai. With D220



如东风力  
Rudong Wind





**案例展示——国际**  
**CASE: JOBSITES OVERSEAS**



越南岬港码头D128柴油锤  
 Port of Da Nang, Vietnam. With D128



秘鲁D128柴油锤  
 Project in Peru. With D128



俄罗斯码头扩建D128柴油锤  
 Port of Russia. With D128



发电D250柴油锤  
 Farm, Jiang su. With D250



天津渤海湾石油平台D220柴油锤  
 Bohai Bay Offshore platform, Tianjing. With D220



珠海横琴岛D138柴油锤  
 Hengqin Island, Zhuhai, with D138



## 独有技术优势

## COMPETITIVE ADVANTAGES OF OUR TECHNOLOGY:

1

### 双燃油泵燃油系统 Double Fuel pump system



消除了使用单泵在打击仰俯桩时上活塞与汽缸之间的间隙而导致的油量不一致。

Double fuel pump system allows evenly distributed fuel injection to the firing chamber while driving batter piles.

2

### 开式和半开式柴油锤悬挂装置 Offshore leads & Suspended rope leaders



具有导向稳定可靠、减少沉桩作业的能量损失。

Our offshore leads and suspended rope leaders improve the safety and stability during the pile driving by protecting from sudden energy loss caused by running piles in softer soils.

3

### 实用型新型浮动式桩帽 Functional and newly designed floating Helmet

提高锤对桩的使用打击效率约20%；提高了桩帽的使用寿命，降低了用户的打桩使用成本。



Obtainable energy output increased by 20%, providing longer service life and lower cost.

4

### 双排列导向板螺栓结构（自主知识产权） Double row of bolts on guide plates

大大提高筒式柴油打桩锤抵御外力冲击的能力，使筒式柴油打桩锤桩基作业时更加安全可靠。

Extra guide plate bolts strengthens the equipment from unwanted outside impacts while also increasing safety of operation and a more robust product.



5

### 冷却系统 Cooling system

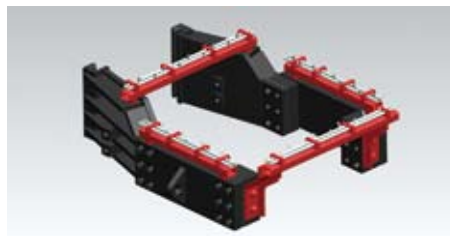

防止过热而引起的提前点火而产生的能量损耗。

Our cooling system avoids pre-ignition caused by over-heating, to ensure less energy loss and make the heat balance.



## 产品技术参数 SPECIFICATIONS

型号		D128 斜桩最大倾 度(1:3/1:1)	D138 斜桩最大 倾斜度 (1:3/1:2)	D160 斜桩最大倾斜 度(1:3/1:2)	D180 斜桩最大倾斜 度(1:3/1:2)	D220 斜桩最大倾斜 度(1:3/1:2)	D260 斜桩最大倾斜 度(1:3/1:2)	
上活塞重量	Impact weight(piston)	kg	12800	13800	16000	18000	22000	26000
每次打击能量	Energy per blow	J	≤426500	≤459800	≤533000	≤590000	≤733000	≤866000
打击次数	Number of blows	1/min	≥36	≥36	≥36	≥36	≥36	≥36
作用于桩上的最大爆炸力	Force of explosion pressure on plie max	kN	3600	3900	4500	5000	6200	7000
起落架导向滑轮钢丝绳最大直径	Permissible rope diameter for deflector sheave of fripping device max.	mm	Ø32	Ø32	Ø37	Ø37	Ø42	Ø42
油耗	柴油 Diesel oil	l/h	36.6	40.5	46	54	70	85
	润滑油 Lubricant	l/h	2.9	2.9	4.5	4.5	6.5	6.5
容量	打直桩时柴油箱容积 Capatcity for vertical pilig Diesel oil tank	l	200	200	240	240	360	360
	润滑油箱容积 Capacity of lubricant oil tank	l	28.6	28.6	40.3	40.3	100	100
重量	柴油锤总重 Diesel pile hammer approx	kg	26300	27300	35000	37500	45400	51500
	起落架重约 Tripping device approx	kg	770	770	1700	1700	2400	2400
	搬运托架/支架 Transpor bracket/crddle approx	kg	950	950				
	工具箱 Tool box approx	kg	125	125	125	125	125	125
尺寸	柴油锤高 (a) Length of Desel pile hammer	mm	7600	7600	8020	8150	7900	8020
	下活塞外径 (b) Outer diametr of impact block	mm	960	960	1070	1070	1200	1200
	起落架翼宽 (c) Overall dimensions measured	mm	1200	1200	1400	1400	1480	1480
	柴油锤宽 (d) Width of Diesel pile hammer	mm	1040	1040	1160	1160	1300	1300
	连接导向板的宽度 (e) Width for connection of guide jaws	mm	910	910	1020	1020	1100	1100
	柴油锤中心前端距离 (f) Diesel hammer center to end distance	mm	625	625	700	700	820	820
	柴油锤中心到导向板螺钉中心的距离 (g) Centre of Diesel pile hammer up to centre of threaded hole for fastening screws of the guide jaws	mm	420	420	465	465	500	500
	柴油锤中心到导向中心的距离 (H) Minmum(standard)distance from centre of Diesel pile hammer up to the centre lead	mm	795	795				
	导向中心间距 (L) Guiding center spacing	mm	600(×Ø102)	600(×Ø102)				

技术参数的更改恕不另行通知。 Specifications are subjected to change without prior notice.

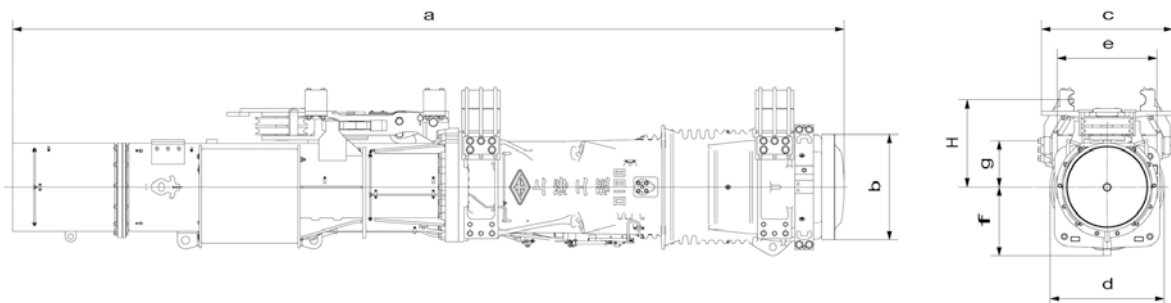

专业服务创造价值 PROFESSIONAL SOLUTIONS CREATE MORE VALUE



## 1 售前支持 PRE-SALE SUPPORT

产品售前为用户当好参谋，无偿为用户提供技术咨询，对用户提出的特殊要求，公司派技术人员无偿到现场进行技术交流并制定解决方案。

Our professional team offers free consulting services to help find the best solutions for your next job.



24小时服务热线：400-888-1749  
24 hours call-center

## 2 服务团队 SEMW SERVICE TEAM

- 公司拥有一支技术精良的服务团队，在重大工程的服务实践中积累了丰富的经验。
- 天津、广州、杭州、江苏等地都设有办事处，配有专门的服务人员，并配备服务专用车辆，随时待命，在4小时内为用户及时提供各种技术服务、产品配件供应等服务。
- 国内其它地区24小时内服务工程师赶赴现场进行处理。
- Our service team has a wide range of professional experience on any size project, large or small.
- We have offices in Tian jin, Guang zhou, Hang zhou and Jiangsu. In these cities, our service team and service vehicles are available at any time. We can be at your jobsite within 4hours with the spare parts and service you need.
- In all other cities in China, our service team can be at your jobsite within 24hours.

## 3 客户关怀 CARING FOR CUSTOMERS

公司拥有一支专业的服务队伍，应用先进的CRM客户管理系统，建立完整的客户档案，定期对客户的使用情况进行回访，并提供主动服务，确保顾客的需求和期望得到满足。

We have a professional team to serve our customers with advanced data base CRM system with files of all our customers. Regular call backs are made to verify products function well and meet your needs.

## 4 监督反馈 CUSTOMERS' FEEDBACK

专门设立了售后服务监督电话：0086-021-56779934，对售后服务过程进行监控，及时处理用户的抱怨。定期对用户进行满意度调查，不断提高服务水平，热忱欢迎新老客户对我们的服务质量进行监督。

Supervisor telephone number: 0086-021-56779934. We will assist the after-sale service and solve any problems with the sense of urgency. Your requests will be well received.

## 5 配件维修 MAINTENANCE AND REPAIRING

建立充足的配件储备，及时满足售后市场需求；公司建立了一套完备的大修理流程，确保返厂维修、保养产品的质量和进度

We have sufficient supplies for spare parts and common wear items, to make sure you have access to quick maintenance and repair.



## 全球营销网络

### THE GLOBAL MARKETING NETWORK

D系列筒式柴油打桩锤，作为公司的拳头产品，不仅仅在国内具有良好的市场声誉；产品批量出口欧洲及俄罗斯，全面覆盖东南亚、成功推广至南北美市场，在非洲市场也拥有广泛且固定的客户群。

Diesel Hammers are the key product of SEMW. They have achieved a good reputation domestically and overseas. SEMW diesel hammers are exported in a large quantity to Europe, Russia, Southeast Asia, North America, South America, and Africa.

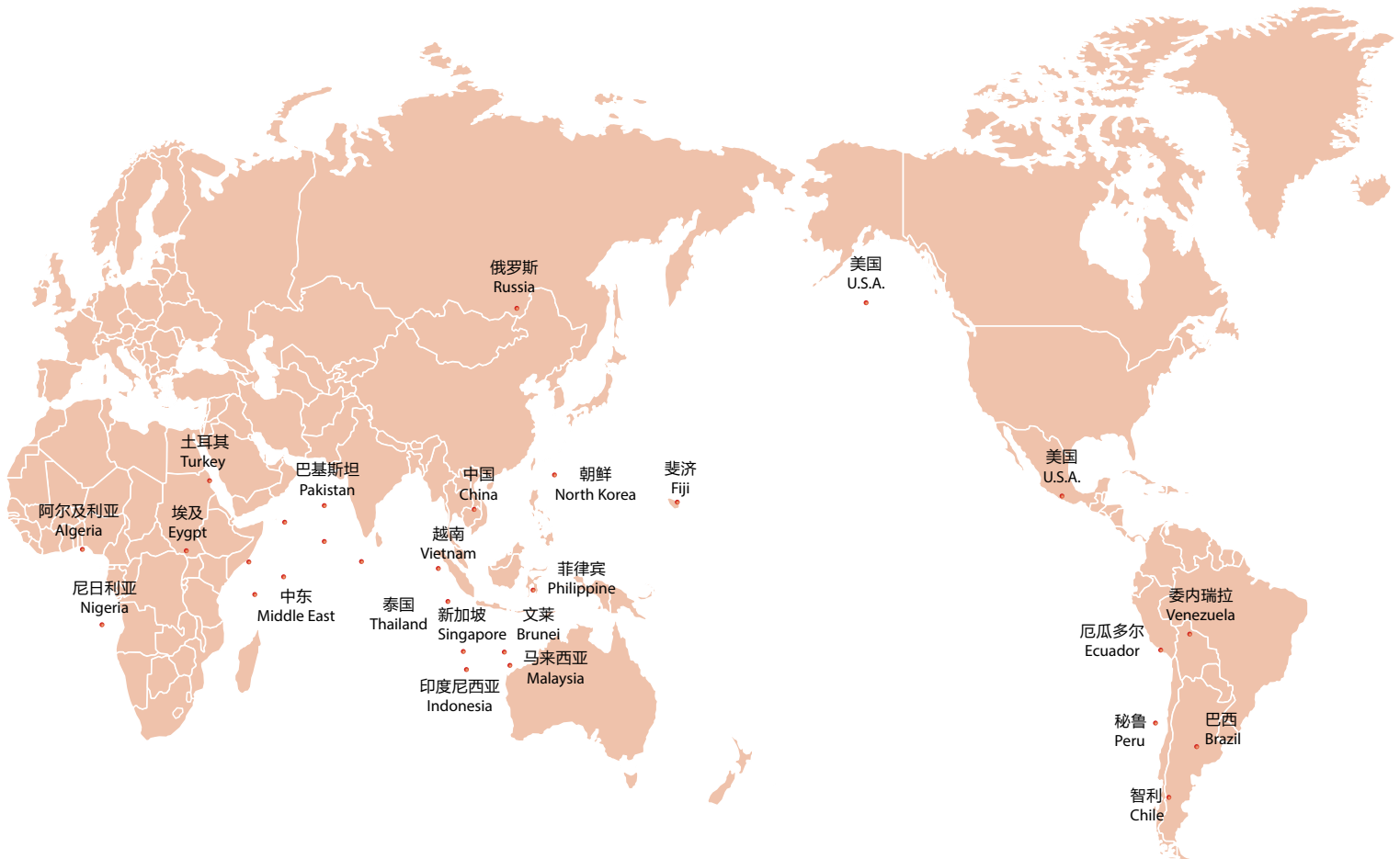

## 上海工程机械有限公司 SHANGHAI ENGINEERING MACHINERY CO.,LTD.

地址：中国上海市宝山区杨南路258号  
邮编：201901  
销售热线：021-56776562 021-56656718  
传真：021-56039876 021-56036931  
配件销售：021-56771749  
外贸热线：021-66308831  
售后服务热线：4008881749  
售后服务监督热线：021-56779934  
电子邮箱：sales@semw.com  
网址：www.semw.com

Add: 258 Yangnan Road Shanghai,China(201901)  
Sales Tel: 021-56776562 021-56656718  
Fax: 021-56039876 021-56036931  
Spare Parts Sales Tel: 021-56771749  
Foreign Trade Tel: 021-66308831  
Service Tel: 4008881749  
Service Supervisor Tel: 021-56779934  
E-mail: sales@semw.com  
Web site: www.semw.com

